

Market and Operational Benefits of HVDC Transmission

PRESENTED BY:

JOHANNES PFEIFENBERGER

PREPARED FOR:

Western Clean Energy Advocates
Transmission Working Group

FEBRUARY 5, 2025



Source: Siemens

Note

This presentation is based in part on the report, [*The Operational and Market Benefits of HVDC to System Operators*](#),

Prepared with colleagues at [The Brattle Group](#) and [DNV](#) and input from industry participants. The [American Council on Renewable Energy \(ACORE\)](#), [GridLab](#), [Clean Grid Alliance](#), [Grid United](#), [Pattern Energy](#), and [Allete](#) commissioned the report.

See also:

[Interregional Transmission Planning with HVDC](#)

[The Operational and Market Benefits of HVDC to System Operators](#)

[Order 1920 Compliance: An Opportunity to Improve Transmission Planning beyond Mandates - Brattle](#)

THE OPERATIONAL AND MARKET BENEFITS OF HVDC TO SYSTEM OPERATORS

PREPARED BY

The Brattle Group
Johannes P. Pfeifenberger
Linquan Bai
Andrew Levitt

DNV

Cornelis A. Plet
Chandra M. Sonnathi

PREPARED FOR

GridLab
American Council on Renewable Energy
Clean Grid Alliance
Grid United
Pattern Energy
Allete

SEPTEMBER 2023



Source: Siemens



HVDC Background

HVDC transmission technology has evolved dramatically over the last 5-10 years

- HVDC offers higher-capacity, longer-distance, lower-loss transmission on a smaller footprint than AC
- The development of voltage-sourced converter (VSC) technology has also offered dramatic improvements in HVDC capabilities
- These VSC-based capabilities are increasingly needed to enhance the existing AC grid

Internationally, approximately 50 GW of VSGHVDC transmission projects are in operation today and approx. 130 GW planned or under development through the end of the decade

- North America accounts for only 3% of all VSC systems in operation worldwide and (almost exclusively due to merchant developers) for approx. 30% of planned and proposed VSC systems

U.S. system operators less familiar with HVDC can benefit from the experience gained overseas (particularly in Europe) ... but significant planning, supply chain, operational, and regulatory challenges need to be addressed

- Our [report](#) with DNV provides a primer on HVDC technology, summarizes available capabilities and experience, addresses misconceptions, and offers recommendations to collaboratively address identified challenges

Grid Planning with HVDC vs. Conventional AC Technologies

HVDC can be more expensive but offers unique advantages and a broader set of capabilities than AC lines. How to choose between HVDC and AC grid technologies within the transmission planning processes?



Making an informed decision requires [multi-value transmission planning](#) that recognizes the increasingly broad set of HVDC use cases and capabilities!

HVDC Use Cases

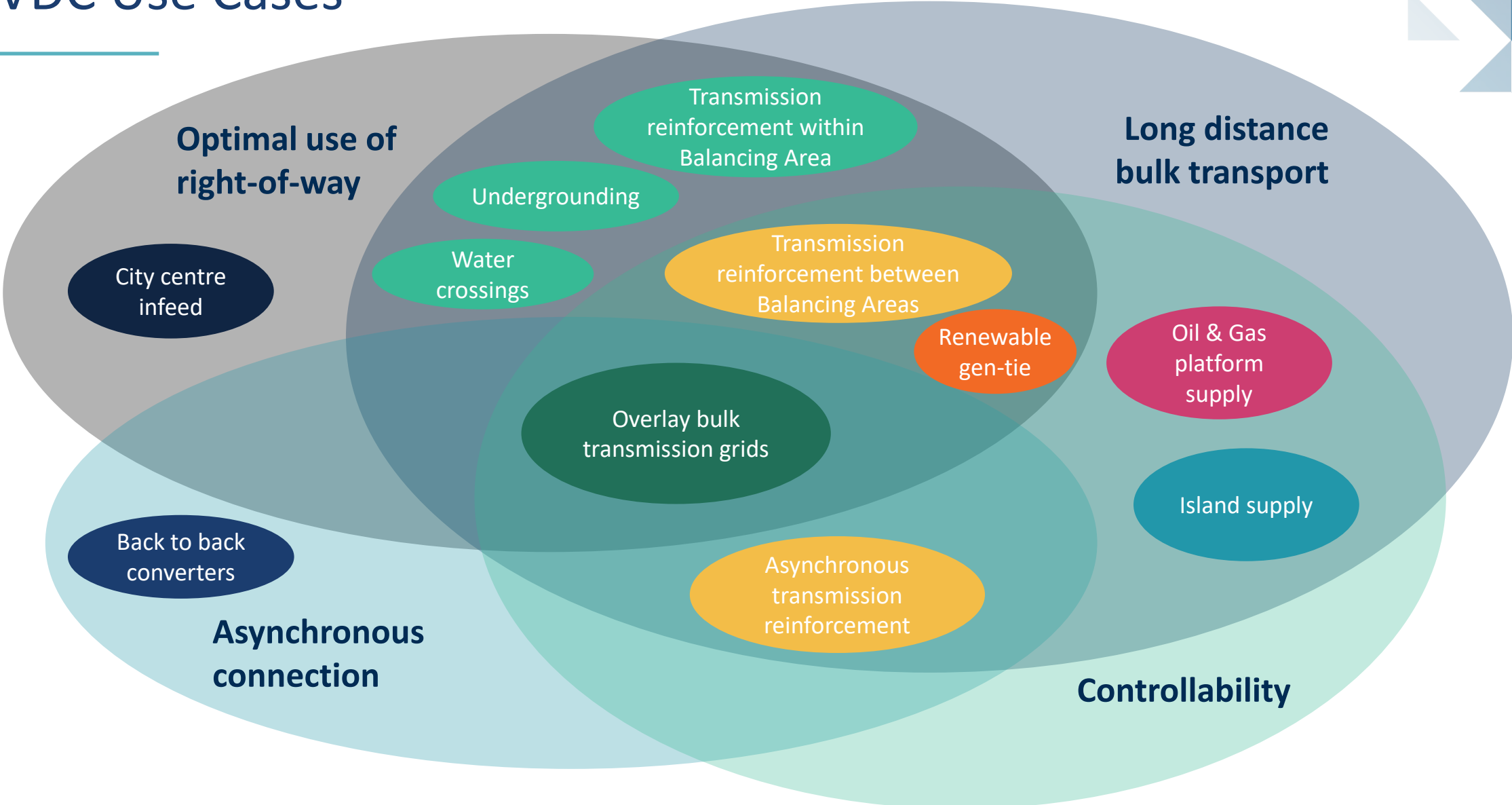

MISO's Comparison of HVDC and 765kV Solutions: Adding multi-value planning is critical



HVDC solutions can offer additional benefits (and avoided AC facilities cost), that lower their net cost:

1. Flow control and market optimization (to reduce AC grid congestion and losses)
2. Dynamic reactive power/voltage control
3. Lower transfer losses
4. Lower ROW and undergrounding cost
5. Lower N-1 contingency
6. AC system dampening; mitigate stability constraints
7. Grid forming, grid services, synthetic inertia, blackstart/restoration inertia, etc.

Comparison of Total Cost per MW-mile
765 kV and +/- 640 kV VSC HVDC

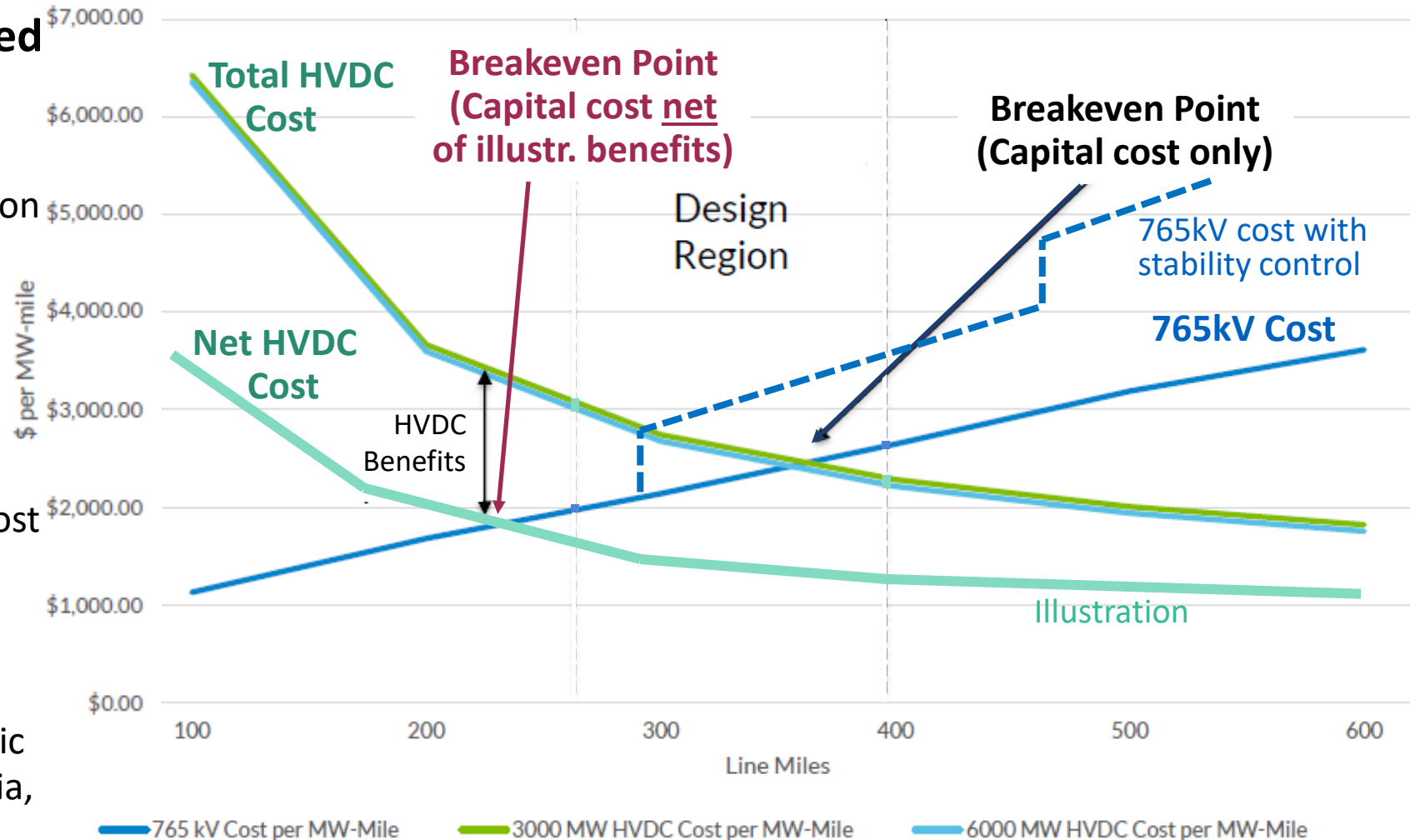

This is a modified version of the chart in slide 29 of MISO, [Discussion of Legacy, 765kV, and HVDC Bulk Transmission](#), March 8, 2023.

Quantifying HVDC Benefits in Transmission Planning (Examples)

HVDC-VSC Capability	Planning Benefits / Options for Quantification
1. Flow control/market optimization	<ul style="list-style-type: none"> • Estimated <u>value</u> of congestion relief and loss reduction on AC grid with nodal production cost models that can optimize HVDC
2. Dynamic reactive power and voltage control	<ul style="list-style-type: none"> • <u>Avoided cost</u> of STATCOMs, SVCs, synchronous condensers
3. Lower long-distance transfer losses	<ul style="list-style-type: none"> • <u>Market value</u> of avoided losses on transmitted energy
4. Smaller footprint/right-of-way (ROW), including for undergrounding option	<ul style="list-style-type: none"> • <u>Lower cost</u> for right-of-way (e.g., 50ft less than for 765kV AC); lower cost of undergrounding; <u>lower risks</u> (permitting etc)
5. Reliability benefits (fault ride-through, lower N-1 contingency for bipoles, voltage support)	<ul style="list-style-type: none"> • Increased <u>transfer capacity</u>; reduced cost of contingency reserves; <u>avoided cost</u> of AC equipment (e.g., additional lines, STATCOMs)
6. AC dynamic stability; power oscillation dampening; mitigate stability constraints on AC grid	<ul style="list-style-type: none"> • <u>Avoided cost</u> of power system stabilizers/supplemental power oscillation damping (POD) controllers with synchronous condensers, batteries, SVCs, STATCOMs, switched shunt equipment, etc. • <u>Value</u> of congestion relief on proxy constraints
7. Grid forming, grid services, synthetic inertia, blackstart/restoration, etc.	<ul style="list-style-type: none"> • <u>Market value</u> or <u>avoided cost</u> of providing the grid services through conventional means

HVDC converter technologies

Many different converter technologies exist, but growth is driven by **modular multi-level voltage source converter (VSC) technology**

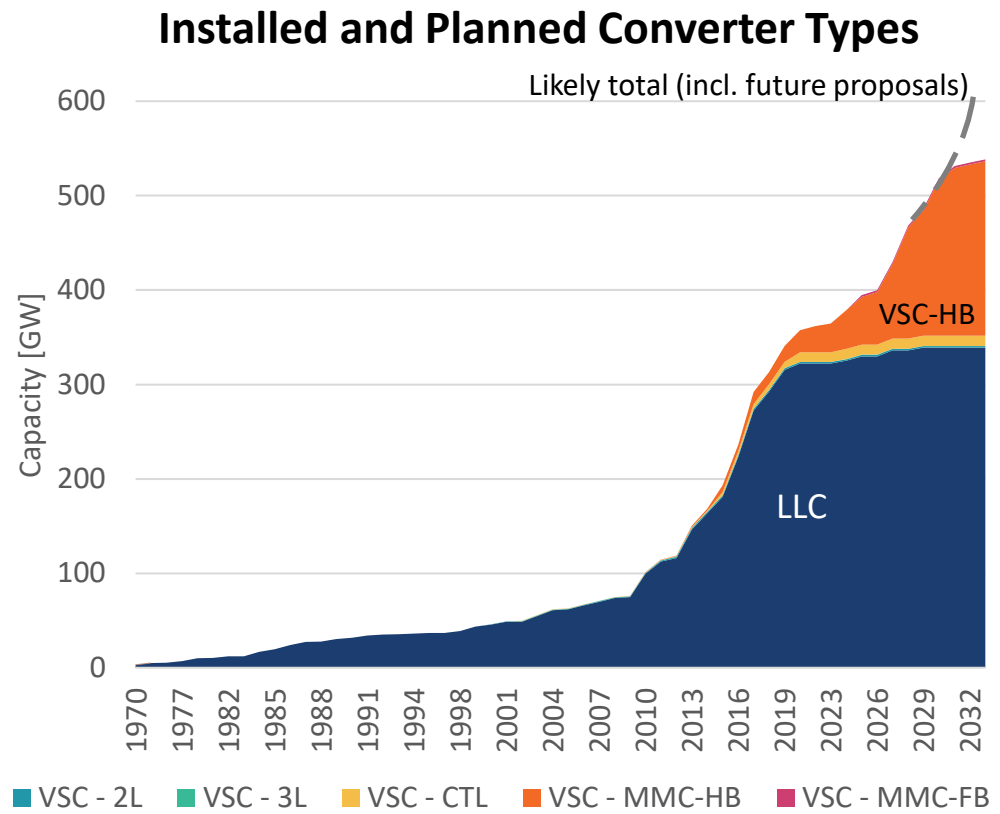
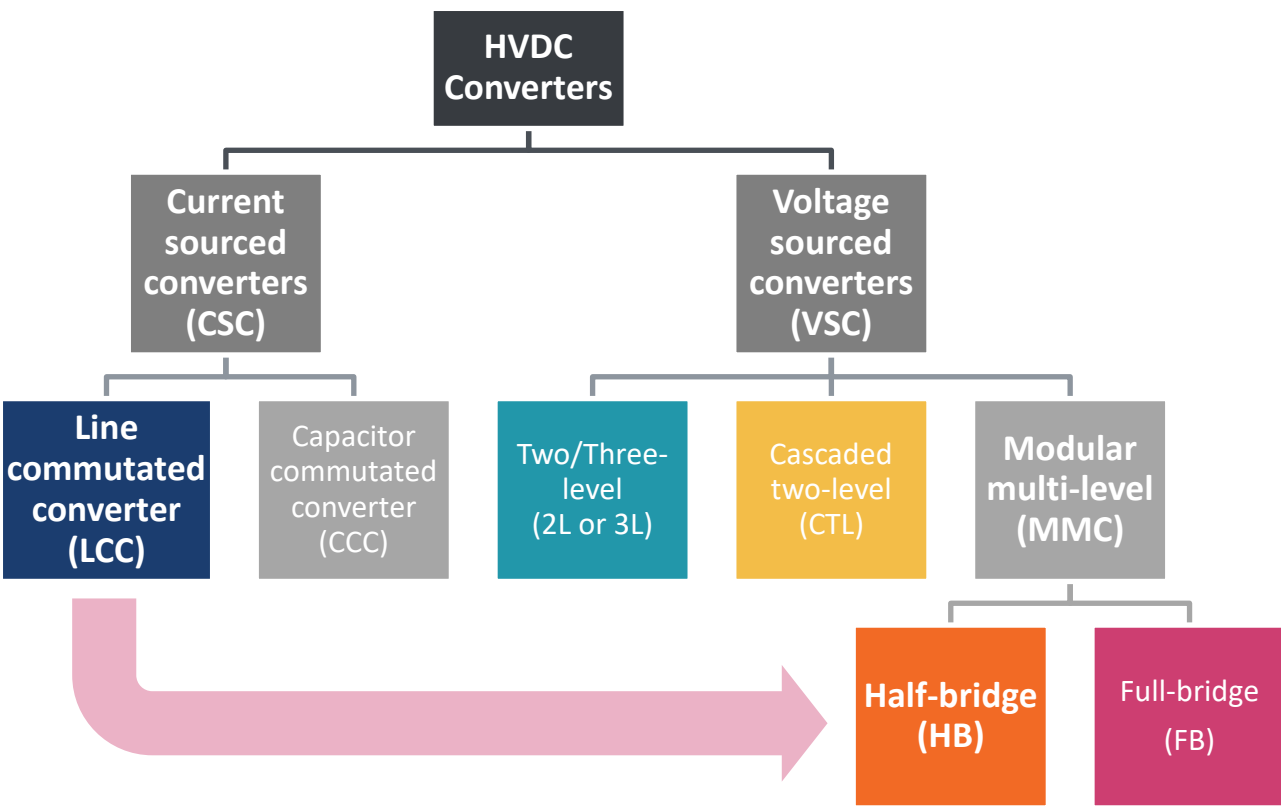

Source: [The Operational and Market Benefits of HVDC Transmission](#)

HVDC Capabilities (with VSC vs. LCC converters)

	Transmission functions	Grid operations support	Autonomous line dispatch	Power quality support	Contingency operations	Reliability & Market optimization
Both LCC & VSC	Real power control Reactive power control (static)	Synthetic inertia* Frequency response Regulation, ramping, spinning reserves	External Power (Tracking) Control AC Line Emulation	Power oscillation damping	Run-back / run-up schemes Emergency energy imports	AC grid power flow optimization Resource adequacy, capacity imports Intertie optimization
VSC only	AC voltage and frequency control* Weak and islanded grid connections*	Voltage support* / Reactive power control (dynamic)		AC phase balancing AC harmonics filtering	Black-start and system restoration*	Frequent and rapid power flow reversal Weak grid connections*

* Requires VSC converters capable of operating in grid-forming mode (but precise capabilities and requirements are evolving and specifications-dependent).

Real-world Experience with Specific HVDC Capabilities

Significant experience (well beyond these examples) already exists with advanced AC grid support capabilities of HVDC

NEMO link Belgium - UK	<ul style="list-style-type: none">• Frequency support and emergency energy
NordLink Norway - Germany	<ul style="list-style-type: none">• Auto-reclosure for overhead line fault clearing and automatic bi- to monopole change
Maritime Link Canada	<ul style="list-style-type: none">• HVDC runback schemes for prevention of overloading of AC lines
Fenno-Skan Sweden - Finland	<ul style="list-style-type: none">• Mitigate AC stability constraints and improve system transfer capability
FIL France – Italy	<ul style="list-style-type: none">• “AC line emulation” and AC grid loss and congestion reduction
INELFE France - Spain	<ul style="list-style-type: none">• Power Oscillation Damping
Skagerrak 4 Norway - Denmark	<ul style="list-style-type: none">• Black-start and system-restoration services
ULTRAnet Germany	<ul style="list-style-type: none">• Converting existing AC overhead line circuits to HVDC

Most Proposed U.S. Interregional Transmission Lines are HVDC

North American HVDC Projects (Existing and Planned/Proposed)

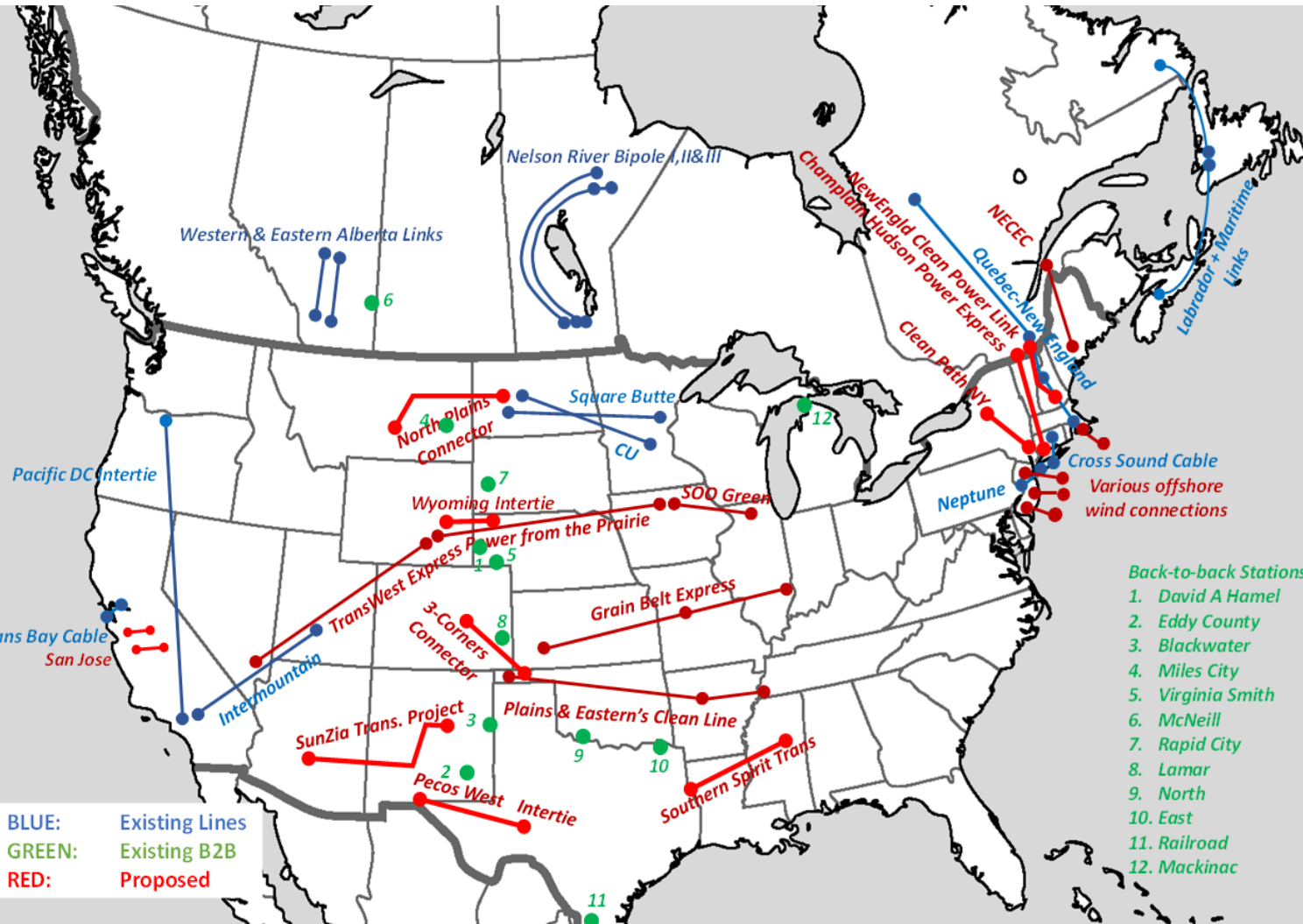

Most U.S. interregional transmission projects are HVDC lines proposed by merchant and OSW developers (i.e, not planned by system operators)

Main HVDC advantages:

- High capacity (1-5 GW), long-distance
- Efficient right of way (including underground and submarine)
- Controllable power flows (for both economic dispatch and during contingencies)
- Synchronous and asynchronous applications
- Grid-forming capability / weak AC grids
- Grid services (to support AC network)

Market Optimization to Capture HVDC Planning Benefits

To ensure that the multiple benefits of HVDC lines (as considered in planning) can actually be captured, CAISO and NYISO have both initiated and implemented several adjustments to their wholesale market design and operations:

- As part of CAISO's Market & Operational Excellence effort, optimization of controllable transmission devices" (e.g., HVDC lines and phase shifters) was added to the CAISO DA+RT markets in 2017:
 - Section 3.2.12: "The CAISO market system [now] optimizes the controllable transmission devices as part of its security constrained economic dispatch and security constrained unit commitment. The CAISO market system will calculate and issue the optimal position for the controllable device to the transmission owner."
- NYISO is implementing optimization of "Internal Controllable Lines" in its energy and capacity markets after the Clean Path NY HVDC line was selected in part for its congestion-relief benefits to the AC grid
- The Western EIM and the new Extended DA Market are able to fully co-optimize the dispatch of interregional HVDC lines (and phase shifters) between the 23 BAs who now participate in EIM (and several already committed to EDAM)
 - The Western EIM and EDAM use CAISO's RT+DA market engines to achieve interregional optimization
- FERC recently approved CAISO's Subscriber PTO (SPTO) framework for full DA+RT market integration of unscheduled capacity on interregional merchant HVDC lines

Near-term Priorities for Capitalizing on HVDC Advantages

1. Develop and implement “[grid codes](#)” for interconnected/embedding HVDC lines (as ENTSO-E has done) that allow grid operators to take full advantage of modern HVDC capabilities
2. Adapt grid [planning tools](#) and [multi-value](#) planning frameworks to take full account of modern HVDC capabilities
3. Provide [training](#) for planning, engineering, and grid operations staff so they are able to take advantage of modern HVDC capabilities (rather than being focused solely on preventing problems that might be encountered)
4. Address current [supply chain](#) challenges by building manufacturing capability through clear long-term commitments
5. Develop [standardization](#) of HVDC functional and interface requirements, and vendor compatibility standards, taking advantage of experience gained in similar European efforts
6. Develop new [regulatory and cost-recovery](#) paradigms that can take advantage of the controllable nature of HVDC technology (both regionally and inter-regionally, including merchant transmission) to permit greater competition and allow for better financial/risk sharing with transmission owners

Longer-term Priorities for Capitalizing on HVDC Advantages



7. Update [grid operations](#) to be able to take full advantage of HVDC grid-services
8. Update [market designs](#) so system operators can co-optimize controllable transmission with generation
9. Implement [inertie optimization](#) to fully utilize existing and new interregional transmission capabilities, including merchant HVDC transmission (such as through CAISO's SPTO framework)*

To implement these recommendations and address the identified challenges, grid operators and planning authorities will need to collaborate with:

- Transmission owners/developers
- HVDC equipment manufacturers
- North American Electric Reliability Corporation (NERC)
- Industry groups, regulators, and states
- U.S. Department of Energy (DOE) and its National Labs

For more detailed discussions, see: [The Operational and Market Benefits of HVDC Transmission](#) and

*[The Need for Inertie Optimization: Reducing Customer Costs, Improving Grid Resilience, and Encourage Interregional Transmission](#)

Takeaways

- **Voltage Source Converters (VSC)**, now the dominant HVDC technology, offer substantial advantages in addressing many of today's transmission needs and grid reliability challenges at lower cost
- **Multi-value planning** is necessary to consider the multiple benefits (and avoided AC grid upgrade costs) offered by VSC-based HVDC transmission solutions
- High capacity, long-distance, controllable, multi-terminal HVDC technology is particularly valuable for **interregional** transmission across multiple balancing areas
- Benefits of VSC-based HVDC lines are particularly pronounced for regions with large supply of low-cost renewable generation in areas with a **weak AC grid** that are distant from major load centers
- Gaining **hands-on experience** with VSC technology (incl. by learning from others) is critical for both (a) reliably integrating and (b) being able to take full advantage of the capabilities offered by new regional and inter-regional HVDC projects



Thank You!

Additional Slides

About the Speaker



Johannes P. Pfeifenberger

**PRINCIPAL
THE BRATTLE GROUP, BOSTON**

Hannes.pfeifenberger@brattle.com

+1.617.234.5624

[\(webbio and publications\)](#)

Johannes (Hannes) Pfeifenberger, a Principal at The Brattle Group, is an economist with a background in electrical engineering and over twenty-five years of experience in wholesale power market design, renewable energy, electricity storage, and transmission. He also is a Visiting Scholar at MIT’s Center for Energy and Environmental Policy Research (CEEPR), a former Senior Fellow at Boston University’s Institute of Sustainable Energy (BU-ISE), a IEEE Senior Member, and currently serves as an advisor to research initiatives by the U.S. Department of Energy, the National Labs, and the Energy Systems Integration Group (ESIG).

Hannes specializes in wholesale power markets and transmission. He has analyzed transmission needs, transmission benefits and costs, transmission cost allocations, and renewable generation interconnection challenges for independent system operators, transmission companies, generation developers, public power companies, industry groups, and regulatory agencies across North America. He has worked on transmission matters in SPP, MISO, PJM, New York, New England, ERCOT, CAISO, WECC, and Canada and has analyzed offshore-wind transmission challenges in New York, New England, and New Jersey.

He received an M.A. in Economics and Finance from Brandeis University’s International Business School and an M.S. and B.S. (“Diplom Ingenieur”) in Power Engineering and Energy Economics from the University of Technology in Vienna, Austria.

HVDC Planning: Transmission Studies

Multi-value planning is critical to be able to take advantage of HVDC capabilities!

Engineering assessments are similar to AC transmission planning: HVDC systems need to be analyzed through a number of studies, sequentially adding more detail, scope, system performance, model fidelity, and temporal granularity as analyses move from planning to design and integration

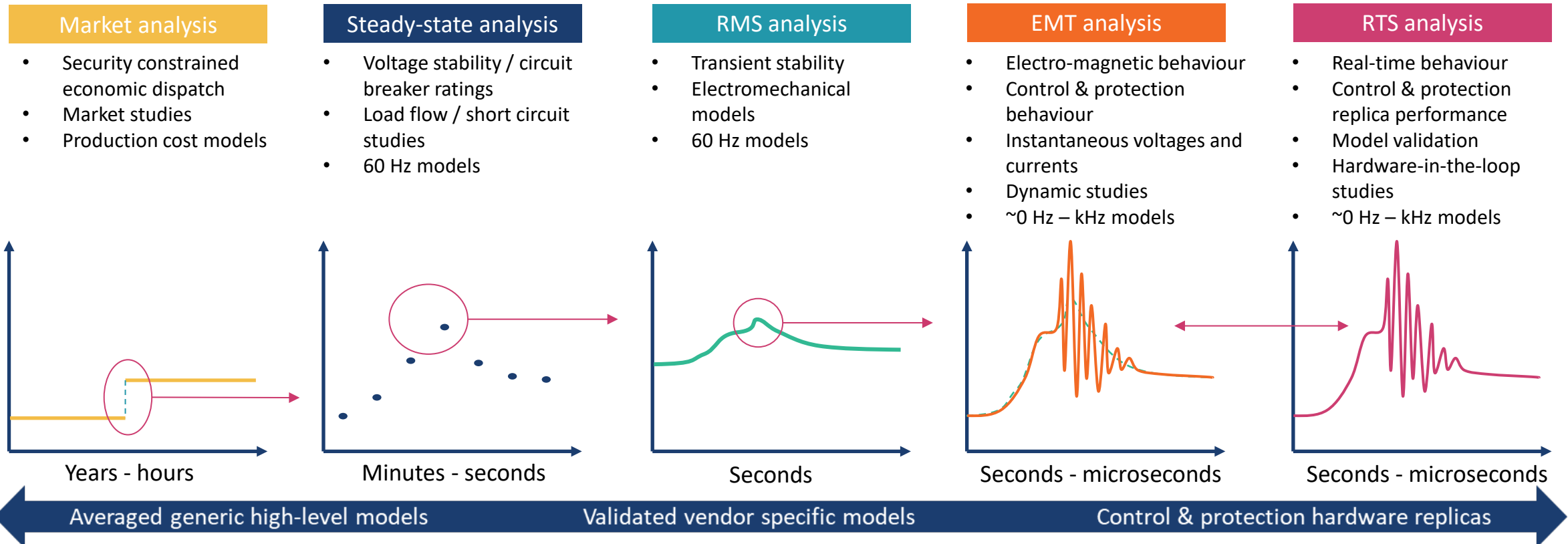

Planning HVDC Conversions/Upgrades of Existing AC Lines

2019 Article: [Converting existing transmission corridors to HVDC to increase transmission capacity | PNAS](#)

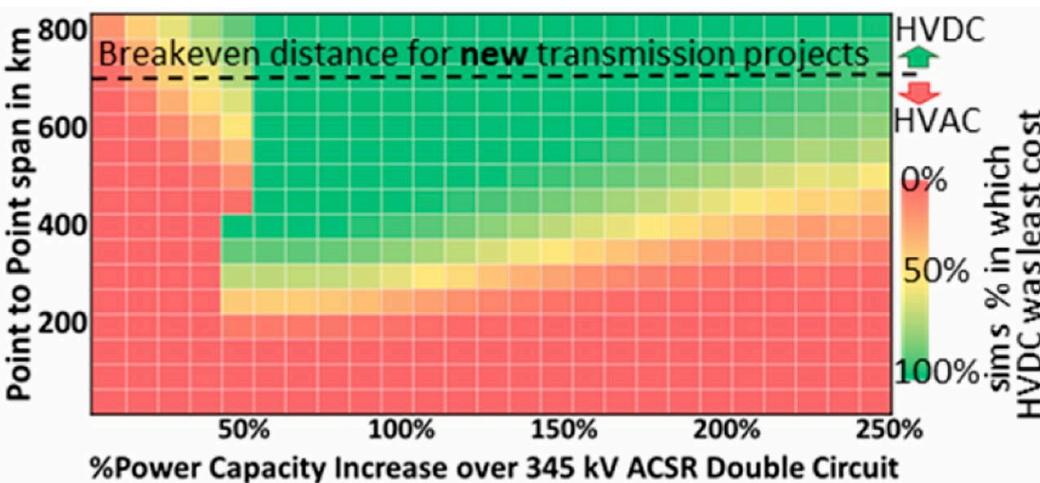
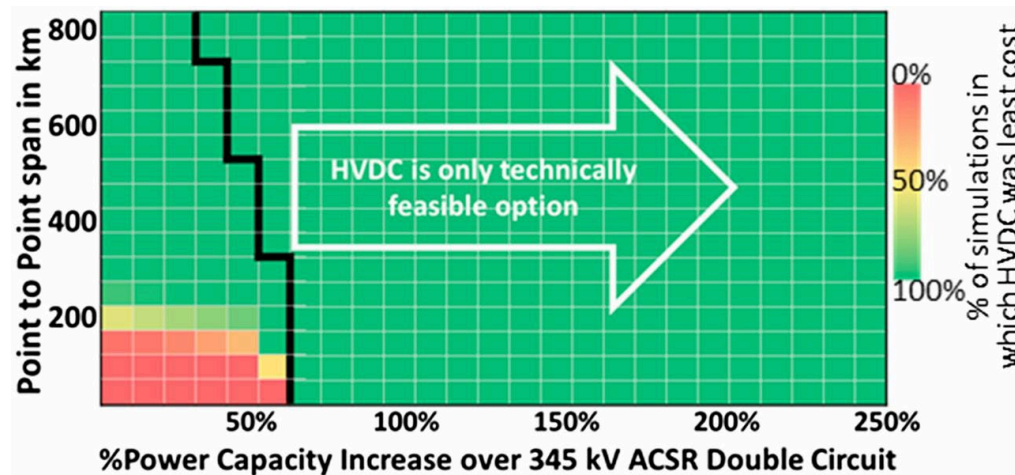

If an existing double-circuit 345kV line has to be upgraded and ROW cannot be expanded:

- AC solutions may not increase capacity by more than 60%
- HVDC conversion is least cost if the transfer capability needs to be increased by more than 60% or the distance is more than 200 km (135 miles)
- Example does not even consider VSC-related benefits

If multiple 345kV or 500kV lines are possible:

- HVDC conversion is preferable if capability needs to be increased by more than 60% and the distance is more than 300 km (185 miles) ... even though the break-even distance for new transmission may be 700 km (430 miles)

Similar analyses can be done for upgrading existing HVAC or HVDC lines at different voltage levels

Example: European Transmission Planning and CBA Framework

ENTSO-E: Standardized Multi-value Benefit-Cost Analysis Framework for EU-wide Transmission Planning (incl. HVDC)

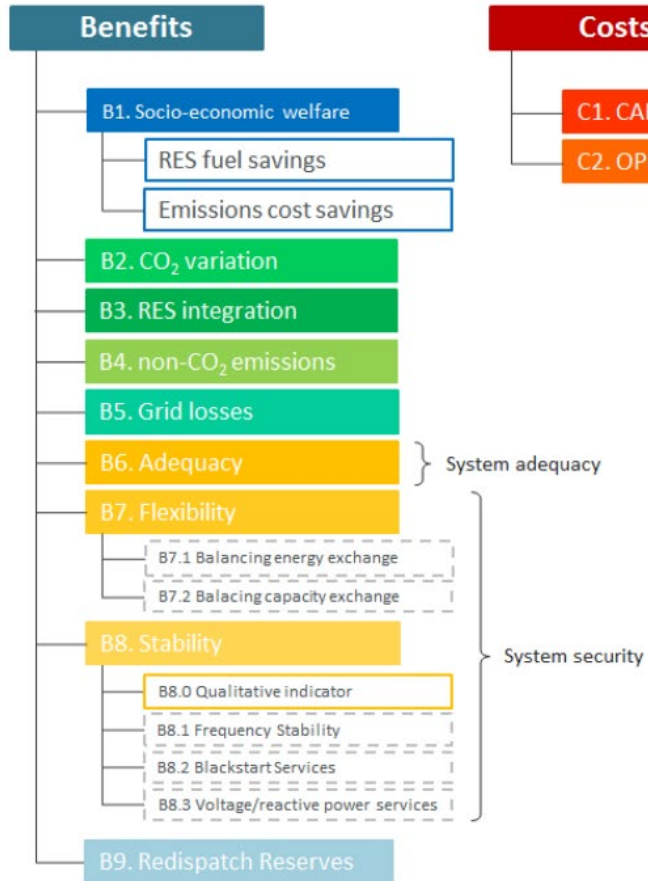

Entso-E Planning and CBA framework

- Forecast-based up to 10 years
- Scenario-based for 10-30 years
- Standardized benefit-cost analysis
- Specifically addresses HVDC benefits: cost savings achievable from optimized dispatch of HVDC lines; transient, voltage, and frequency stability benefits of HVDC lines; blackstart services; voltage and reactive power support

10-Year Network Development Plan (TYNDP) to Evaluate 176 Transmission, 33 Storage Projects

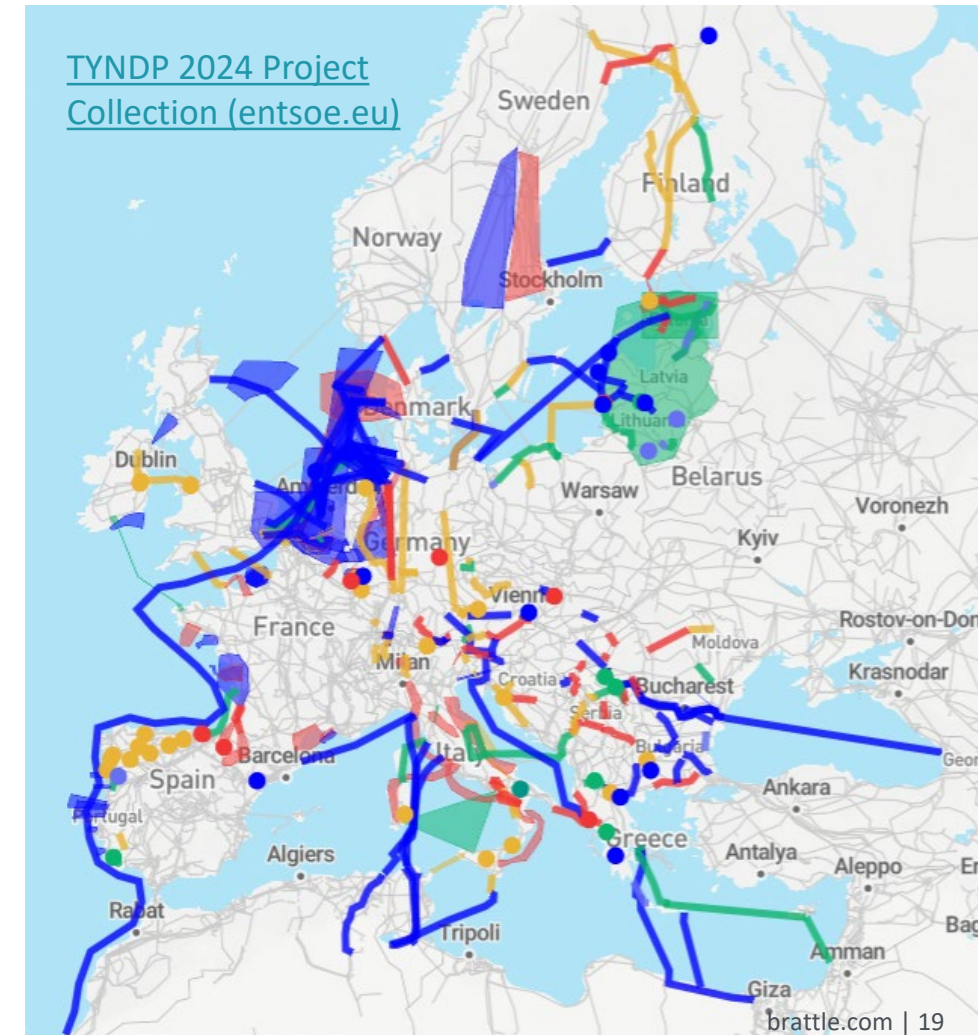

Source: ENTSO-e, [4th ENTSO-e Guideline for Cost Benefit Analysis of Grid Development Projects](#), Oct 18, 2023, Figure 8; [TYNDP 2024 Implementation Guidelines](#), Mar 4, 2024. For a summary of the ENSTO-e framework, incl. HVDC, see pp. 77-80 [here](#).

Example: CAISO HVDC Solutions

CAISO has been a leader in considering HVDC solutions in transmission planning:

- Transbay Cable (TBC), CAISO's first internal HVDC-VSC line, operational since 2013 (1st in North America)
- In its recent Transmission Planning Processes (TPPs), CAISO considered a dozen HVDC solutions and approved two (all VSC, some multi-terminal):

For example: “the HVDC alternatives resulted in better performance from the power flow perspective as a result of controllability of the HVDC source. The HVDC alternative also provides benefits in reducing local capacity requirements in the San Jose subarea and overall Greater Bay Area that reduces reliance on the local gas generation.”

- Improvements in California planning studies for HVDC continue:
 - ▶ CAISO continues efforts of finding and promoting standard models and approaches for assessing HVDC VSC
 - ▶ For example, CAISO is in the process of assessing applicable models for dynamic stability analysis
 - ▶ Cal Western has been working with industry experts to develop dynamic stability models for HVDC VSC lines and to find modeling solutions that work in a PSLF environment; they are now able to do dynamic analysis of HVDC VSC lines using PSLF.

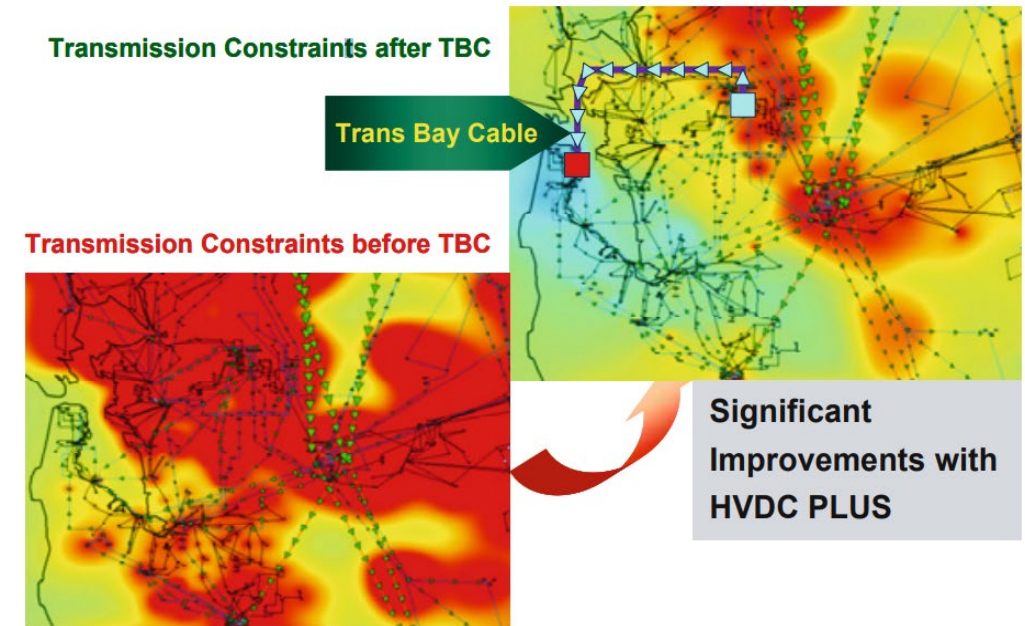

Source: [HVDC PLUS – Basics and Principle of Operation, Siemens](#)

Example: HVDC Benefits Considered by CAISO



CAISO's 2022 TPP Report discusses a number of VSC-HVDC-related benefits that are considered in its Transmission Planning Process:

- “Transmission over long distances with overhead lines or underground/subsea cables; there is no practical limit on how far power could be transmitted with HVDC lines”
- “smaller rights-of-way”
- “Power flow on the line is set by the operator”
- “The AC system the VSC-HVDC converters are connected to does not need specific minimum short circuit levels”
- “Does not require reactive power support at the converter station”
- “Multi-terminal configuration is less complicated”
- “VSC-HVDC is suitable for delivering power to urban areas and systems with low short-circuit levels”
- “The converter stations are physically smaller compared to LCC HVDC stations and therefore more suitable to deliver power to urban centers”
- VSC HVDC lines can be combined with other technologies: e.g., to create a “hybrid AC and HVDC solution” to connect 14,428 MW of wind with two VSC-HVDC, two LCC-HVDC, and two 500kV AC lines

Added Detail: Use Cases for HVDC Transmission

Source: [The Operational and Market Benefits of HVDC Transmission](#)

Use Case	Description/Features
1. Integration of remote renewables and offshore wind	<p>More cost effective and stable for long-distance access to remote renewables</p> <p>Offers relatively high availability and capacity, low maintenance, and low losses for long distance transmission of renewables</p> <p>Superior controllability for integrating volatile renewable generation and stabilizing AC networks</p> <p>Allows for large export capacity from weak (but renewable rich) portions of the AC grid</p>
2. Long-distance bulk-transmission	<p><u>Overhead HVDC lines</u>: Offers lower-cost, high-capacity transmission over longer distances, with lower losses, and less right of way than AC transmission lines</p> <p><u>Underground and submarine HVDC cables</u>: offers lower-cost, high-capacity transmission over long distances; using underground HVDC minimizes environmental impact and reduces outage risks</p>
3. Corridor transfer capability increase	<p><u>Conversions of AC transmission to HVDC (and upgrades of aging HVDC lines)</u> allow for substantial increases in the transfer capacity of existing transmission lines and corridors without the need for additional right of way and new greenfield transmission lines</p>
4. Interconnections between asynchronous grids	<p>Allows power transmission between AC grids that are not synchronized</p> <p>Asynchronous HVDC interconnection also allows for precise control of power transfer (for both reliability and trading) and the blocking of cascading failures without an increase of the grids' short-circuit current</p> <p>Two asynchronous systems can use HVDC to provide each other frequency support, balancing power, and operating reserve when needed</p>
5a. Interconnections between BAs within a synchronous region	<p>An HVDC link connecting neighboring balancing areas within a single synchronous AC network allows the BAs to exchange energy (for reliability and trading), provide balancing power, and share operating reserves (similar to HVAC transmission links)</p> <p>HVDC can additionally provide AC grid support services, such as power flow control (avoiding the need for phase shifters), dynamic voltage control (avoiding the need for STATCOMs), and system stability and dynamic support</p>
5b. Transmission Embedded within a single BA ⁵⁷	<p>HVDC transmission connected to different points of the AC grid within a single balancing area provides large transfer capability without imposing stability issues or loop flows on the AC grid</p> <p>It also provides power flow control functions within the AC network (such as for congestion management and loss reduction), dynamic voltage control (at each interconnection point), system stability improvement (including mitigation of stability-based AC transmission constraints), and the mitigation of AC-grid contingency impacts and system cascading failure risks</p>
6. Infeed to load centers/urban areas	<p>Allows for more cost-effective, high-capacity transmission feeds into urban areas and other large load centers where overhead lines are not an option or rights-of-way are very limited</p> <p>VSC-based underground DC transmission can be added to existing transmission rights-of-way to reliably deliver more power to load centers without increasing short-circuit levels</p> <p>Provides additional reliability services, such as dynamic voltage support within the load center</p>
7. Providing power to remote locations (including small islanded grids and offshore platforms)	<p>VSC HVDC transmission can support weak or even passive islanded or remote grids, stabilize the islanded AC networks, and improve grid performance in the event of power disturbances</p>

	Type of AC grid connection →	Islanded AC grids		Strong / weak AC grids			
		Integration of remote renewables	Providing power to remote locations	Connections between asynchronous regions	Embedded		
	Type of use case →				Embedded within a synchronous region	Embedded within a single BA	Infeed to load centers/urban areas
	Grid Service ↓						
Transmission functions	AC voltage and frequency control	VSC	VSC				
	Reactive power control (static)	VSC	VSC	VSC	VSC	VSC	VSC
	Real power control	HVDC	HVDC	HVDC	HVDC	HVDC	HVDC
Grid operations support	Voltage support/reactive power control (dynamic)	VSC	VSC	VSC	VSC	VSC	VSC
	Synthetic inertia*	*		VSC	*	*	*
	Frequency response*	VSC		HVDC	*	*	*
Autonomous line dispatch	Regulation, ramping, spinning reserves*	VSC		HVDC	HVDC	*	*
	External Power (Tracking) Control			HVDC	HVDC	HVDC	HVDC
Power quality support	AC Line Emulation			HVDC	HVDC	HVDC	HVDC
	AC grid oscillation damping			HVDC	HVDC	HVDC	HVDC
Contingency operations	AC phase balancing			VSC	VSC	VSC	VSC
	Run-back / run-up schemes			HVDC	HVDC	HVDC	HVDC
	Emergency energy imports			HVDC	HVDC	HVDC	HVDC
Reliability & Market Optimization	Black-start and system restoration	VSC	VSC	VSC	VSC	VSC	VSC
	AC grid power flow optimization			HVDC	HVDC	HVDC	HVDC
	Resource adequacy, capacity imports*			HVDC	HVDC		
	Intertie optimization*			HVDC	HVDC		

HVDC = both LCC & VSC can provide the service

VSC = only VSC converters can provide the service

* requires coordination with neighboring system or connected resource (e.g. storage)

Examples of Available HVDC-Related Training

Topic	Audience	Specificity	Trainer	Examples
HVDC technology & systems	System planners, technologists, project engineers, researchers	Generic, could be focused on different technology groups, or systems	Consultants, universities, industry associations, vendors, etc.	<ul style="list-style-type: none"> • HVDC Converter Technologies training course (dnv.com) • Training – The National HVDC Centre • Services - TransGrid Solutions (myftpupload.com)
HVDC modelling & analysis	System planners, project engineers, researchers	Generic	Consultants, universities, industry associations, vendors,...	<ul style="list-style-type: none"> • Training & Support - RTDS Technologies • HVDC Control & Project Management PSCAD • HVDC-VSC System Training - RTE international (rte-international.com)
HVDC project management	Project teams	Generic	Consultants, industry associations, vendors,...	
HVDC operation (operator training)	Grid Operators	Vendor specific	Vendors, consultants,...	<ul style="list-style-type: none"> • Training Hitachi Energy • High Voltage Direct Current (HVDC) Systems e-learning – GE Grid Solutions
HVDC maintenance	Maintenance teams	Vendor specific	Vendors, consultants,...	
Market operations	Market Operators	TSO specific	TSO, market operator, consultants	<ul style="list-style-type: none"> • Controllable Lines Proposal (nyiso.com)

HVDC Project Size and Commercial Readiness of HVDC Elements

Commercial Readiness:

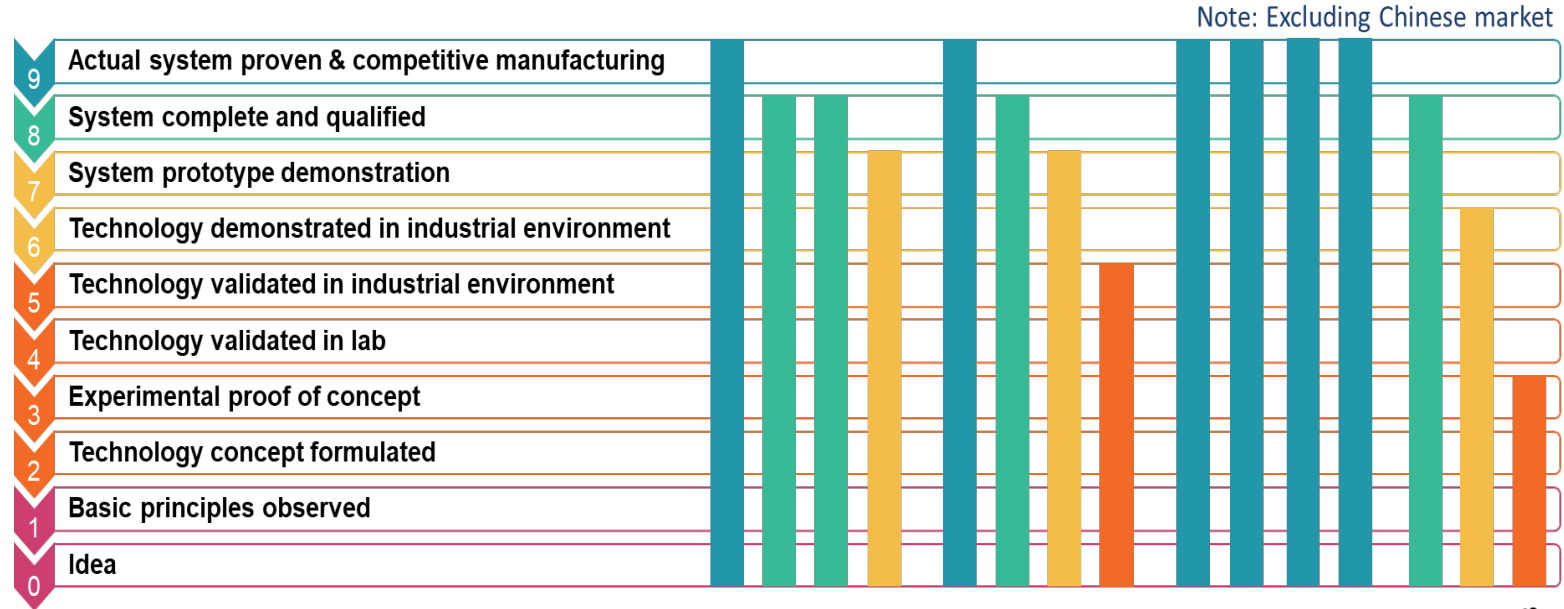

VSC Project Size and Voltage:

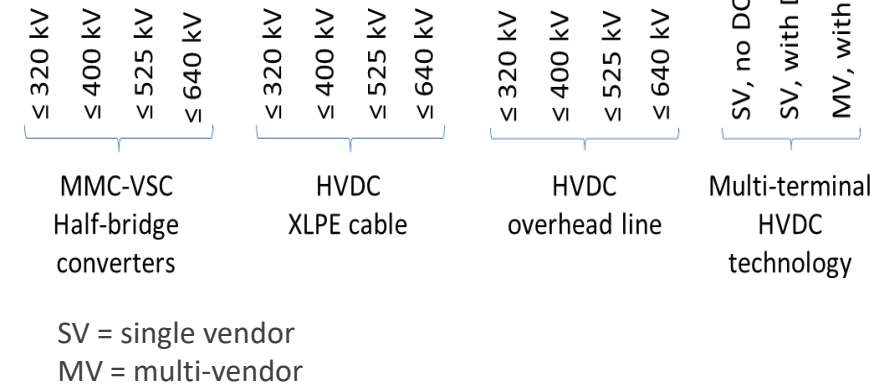
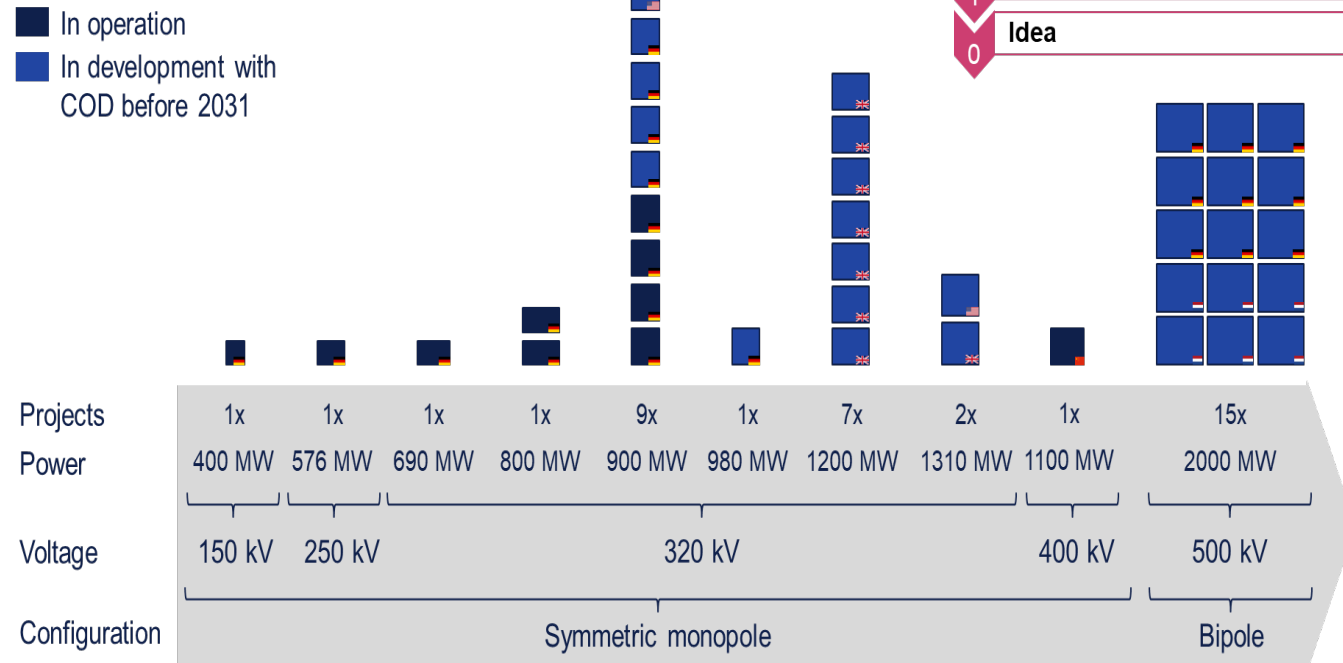

Source: [The Operational and Market Benefits of HVDC Transmission](#)

Challenges to the utilization of HVDC capabilities

Outdated, incomplete and uncoordinated technical standardization

- Existing standards do not fully take into account characteristics of modern HVDC transmission technology.
 - ▶ MMC-VSC converter technology
 - ▶ Underground and submarine HVDC cable technology
- Some ongoing standardization initiatives are overtly conservative and reduce ability to realize VSC-HVDC benefits
- Existing standards do not cover all HVDC applications
 - ▶ IEEE P2800 does not cover offshore converter AC performance requirements
 - ▶ No operational guideline for DC grid behavior
- HVDC standardization is not coordinated across regions and between functional disciplines
 - ▶ Health, safety, and environment
 - ▶ System performance and design
 - ▶ Technology & equipment (to ensure modularity and compatibility)
 - ▶ Test, measurement, & analysis
 - ▶ Communication and Cyber security

Challenges to the utilization of HVDC capabilities (cont'd)

Supply chain challenges

- Small number of HVDC suppliers
- Limited production capacity of the vendor in terms of engineering staff, number of production lines, limited transport and installation equipment, availability of testing facilities
- Technical maturity of the vendors' HVDC technology
- Project management experience of the vendor
- Country of origin of the vendor and the resulting export restrictions
- Sub-supplier/partnership strategy of vendors

Planning, regulatory, and market-design challenges

- Lack of proactive, multi-value planning processes that are able to capture long-term HVDC-related values
- Lack of grid codes to ensure that system operators are able to take advantage of the technology's grid-supporting HVDC capabilities
- Limited operator experience
- Lack of market-clearing software able to co-optimize generation and controllable HVDC transmission facilities

Examples of Brattle Reports on Regional and Interregional Transmission Planning and Benefit-Cost Analyses

Well-Planned Electric Transmission Saves Customer Costs:
Improved Transmission Planning is Key to the Transition to a Carbon-Constrained Future

PREPARED FOR
 **Link: [Well-Planned Transmission](#)**

PREPARED BY
Judy W. Chang
Johannes P. Pfeifenberger

May 2014

THE **Brattle** GROUP

Toward More Effective Transmission Planning:
Addressing the Costs and Risks of an Insufficiently Flexible Electricity Grid

PREPARED FOR
 **Link: [Effective Transmission Planning](#)**

PREPARED BY
Johannes P. Pfeifenberger
Judy W. Chang
Akash Shellenbranath

April 2015

The Brattle Group

Link: [Transmission Benefits](#)

The Benefits of Electric Transmission: Identifying and Analyzing the Value of Investments

July 2013

Judy W. Chang
Johannes P. Pfeifenberger
J. Michael Hagerty

Link: [Diversity Value](#)

 Boston University Institute for Sustainable Energy

The Value of Diversifying Uncertain Renewable Generation through the Transmission System

September • 2020



Transmission Planning for the 21st Century: Proven Practices that Increase Value and Reduce Costs

Link: [Brattle Grid Strategies](#)



PREPARED BY

The Brattle Group:
Johannes Pfeifenberger
Kasparas Spokas
J. Michael Hagerty
John Tsoukalis

Grid Strategies:
Rob Gramlich
Michael Goggin
Jay Caspary
Jesse Schneider

OCTOBER 2021



 

A Roadmap to Improved Interregional Transmission Planning

Link: [Interregional Roadmap](#)

PREPARED BY
Johannes P. Pfeifenberger
Kasparas Spokas
J. Michael Hagerty
John Tsoukalis

November 30, 2021



Summarizes proven approaches to quantifying various benefits

Brattle Group Publications on Transmission

Gramlich, Hagerty, et al., [Unlocking America's Energy: How to Efficiently Connect New Generation to the Grid](#), Grid Strategy and Brattle, August 2024.

DeLosa, Pfeifenberger, Joskow, [Regulation of Access, Pricing, and Planning of High Voltage Transmission in the US](#), MIT-CEEPR working paper, March 7, 2024.

Pfeifenberger, [How Resources Can Be Added More Quickly and Effectively to PJM's Grid](#), OPSI Annual Meeting, October 17, 2023.

Pfeifenberger, Bay, et al., [The Need for Intertie Optimization: Reducing Customer Costs, Improving Grid Resilience, and Encourage Interregional Transmission](#), October 2023.

Pfeifenberger, Plet, et al., [The Operational and Market Benefits of HVDC to System Operators](#), for GridLab, ACORE, Clean Grid Alliance, Grid United, Pattern Energy, and Allete, September 2023.

Pfeifenberger, DeLosa, et al., [The Benefit and Urgency of Planned Offshore Transmission](#), for ACORE, ACP, CATF, GridLab, and NRDC, January 24, 2023.

Brattle and ICC Staff, [Illinois Renewable Energy Access Plan: Enabling an Equitable, Reliable, and Affordable Transition to 100% Clean Electricity for Illinois](#), December 2022.

Pfeifenberger et al., [New Jersey State Agreement Approach for Offshore Wind Transmission: Evaluation Report](#), October 26, 2022.

Pfeifenberger, DeLosa III, [Transmission Planning for a Changing Generation Mix](#), OPSI 2022 Annual Meeting, October 18, 2022.

Pfeifenberger, [Promoting Efficient Investment in Offshore Wind Transmission](#), DOE-BOEM Atlantic Offshore Wind Transmission Economics & Policy Workshop, August 16, 2022.

Pfeifenberger, [Generation Interconnection and Transmission Planning](#), ESIG Joint Generation Interconnection Workshop, August 9, 2022.

Pfeifenberger and DeLosa, [Proactive, Scenario-Based, Multi-Value Transmission Planning](#), Presented at PJM Long-Term Transmission Planning Workshop, June 7, 2022.

Pfeifenberger, [Planning for Generation Interconnection](#), Presented at ESIG Special Topic Webinar: Interconnection Study Criteria, May 31, 2022.

RENEW Northeast, [A Transmission Blueprint for New England](#), Prepared with Borea and The Brattle Group, May 25, 2022.

Pfeifenberger, [New York State and Regional Transmission Planning for Offshore Wind Generation](#), NYSERDA Offshore Wind Webinar, March 30, 2022.

Pfeifenberger, [The Benefits of Interregional Transmission: Grid Planning for the 21st Century](#), US DOE National Transmission Planning Study Webinar, March 15, 2022.

Pfeifenberger, [21st Century Transmission Planning: Benefits Quantification and Cost Allocation](#), for NARUC members of the Joint Federal-State Task Force on Electric Transmission, January 19, 2022.

Pfeifenberger, Spokas, Hagerty, Tsoukalis, [A Roadmap to Improved Interregional Transmission Planning](#), November 30, 2021.

Pfeifenberger, Tsoukalis, Newell, ["The Benefit and Cost of Preserving the Option to Create a Meshed Offshore Grid for New York,"](#) Prepared for NYSERDA with Siemens and Hatch, November 9, 2022.

Pfeifenberger, [Transmission—The Great Enabler: Recognizing Multiple Benefits in Transmission Planning](#), ESIG, October 28, 2021.

Pfeifenberger et al., [Transmission Planning for the 21st Century: Proven Practices that Increase Value and Reduce Costs](#), Brattle-Grid Strategies, October 2021.

Pfeifenberger et al., [Initial Report on the New York Power Grid Study](#), prepared for NYPSC, January 19, 2021.

Van Horn, Pfeifenberger, Ruiz, ["The Value of Diversifying Uncertain Renewable Generation through the Transmission System,"](#) BU-ISE, October 14, 2020.

Pfeifenberger, Newell, Graf and Spokas, ["Offshore Wind Transmission: An Analysis of Options for New York"](#), prepared for Anbaric, August 2020.

Pfeifenberger, Newell, and Graf, ["Offshore Transmission in New England: The Benefits of a Better-Planned Grid,"](#) prepared for Anbaric, May 2020.

Tsuchida and Ruiz, ["Innovation in Transmission Operation with Advanced Technologies,"](#) T&D World, December 19, 2019.

Pfeifenberger, ["Cost Savings Offered by Competition in Electric Transmission,"](#) Power Markets Today Webinar, December 11, 2019.

Chang, Pfeifenberger, Sheilendranath, Hagerty, Levin, and Jiang, ["Cost Savings Offered by Competition in Electric Transmission: Experience to Date and the Potential for Additional Customer Value,"](#) April 2019 and ["Response to Concentric Energy Advisors' Report on Competitive Transmission,"](#) August 2019.

Ruiz, ["Transmission Topology Optimization: Application in Operations, Markets, and Planning Decision Making,"](#) May 2019.

Chang, Pfeifenberger, ["Well-Planned Electric Transmission Saves Customer Costs: Improved Transmission Planning is Key to the Transition to a Carbon-Constrained Future,"](#) WIRES&Brattle, June 2016.

Newell et al. ["Benefit-Cost Analysis of Proposed New York AC Transmission Upgrades,"](#) on behalf of NYISO and DPS Staff, September 15, 2015.

Pfeifenberger, Chang, and Sheilendranath, ["Toward More Effective Transmission Planning: Addressing the Costs and Risks of an Insufficiently Flexible Electricity Grid,"](#) WIRES and Brattle, April 2015.

Chang, Pfeifenberger, Hagerty, ["The Benefits of Electric Transmission: Identifying and Analyzing the Value of Investments,"](#) on behalf of WIRES, July 2013.

Chang, Pfeifenberger, Newell, Tsuchida, Hagerty, ["Recommendations for Enhancing ERCOT's Long-Term Transmission Planning Process,"](#) October 2013.

Pfeifenberger and Hou, ["Seams Cost Allocation: A Flexible Framework to Support Interregional Transmission Planning,"](#) on behalf of SPP, April 2012.

Pfeifenberger, Hou, ["Employment and Economic Benefits of Transmission Infrastructure Investment in the U.S. and Canada,"](#) on behalf of WIRES, May 2011.

Brattle Group Practices and Industries

ENERGY & UTILITIES

Competition & Market
Manipulation
Distributed Energy
Resources
Electric Transmission
Electricity Market Modeling
& Resource Planning
Electrification & Growth
Opportunities
Energy Litigation
Energy Storage
Environmental Policy, Planning
and Compliance
Finance and Ratemaking
Gas/Electric Coordination
Market Design
Natural Gas & Petroleum
Nuclear
Renewable & Alternative
Energy

LITIGATION

Accounting
Analysis of Market
Manipulation
Antitrust/Competition
Bankruptcy & Restructuring
Big Data & Document Analytics
Commercial Damages
Environmental Litigation
& Regulation
Intellectual Property
International Arbitration
International Trade
Labor & Employment
Mergers & Acquisitions
Litigation
Product Liability
Securities & Finance
Tax Controversy
& Transfer Pricing
Valuation
White Collar Investigations
& Litigation

INDUSTRIES

Electric Power
Financial Institutions
Infrastructure
Natural Gas & Petroleum
Pharmaceuticals
& Medical Devices
Telecommunications,
Internet, and Media
Transportation
Water

Our Offices



Clarity in the face of complexity

The Power of Economics™



Brattle

